

High Frequency Online UPS
CNH110
Series 1-3KVA

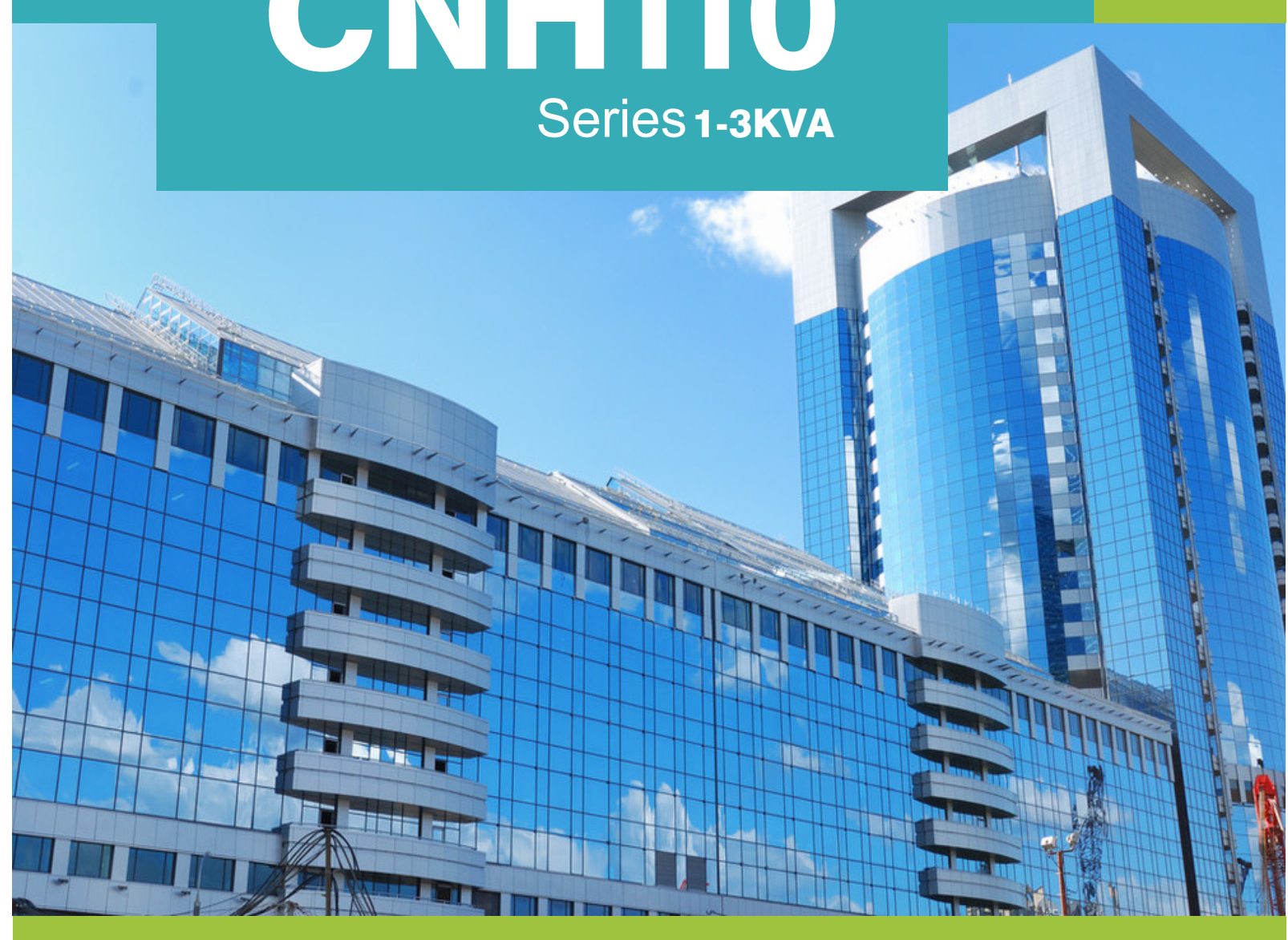

CONSNANT

Constant Electric Power
www.consnant.com



CNH110 Online UPS



PERFORMANCE AND FUNCTIONALITY

- Zero Transfer time
True Double Conversion Online UPS, Provide most comprehensive protect mission critical equipment from wide range power quality issues
- DSP Digital Control Based
Advance DSP base digital control bring high performance of high input Power factor, low distortion , supply the load with perfect sine wave AC power supply
- Ultra Wide Input Mains range
Strong compatible with ultra with electric environment, stay well with ultra wide range mains of 90V~300V, 40~70Hz ,dramatically reduce battery discharge , prolong battery life
- Best Loading Capability
Up to 0.9 Output Power Factor, 50/60 Hz Automatically adapting, selectable voltage , perfectly match all kind of application
- Genset Compatible
Capable of work with wide range of Genset, isolate fluctuation and noise from Genset , provide stable and clean power supply to the user equipment.
- High Input power factor
Thanks to digital controlled PFC Technology, >0.99 input power factor, effectively avoid power pollution , save energy expense for customer
- Reliable design
Made with strong Glass fiber base (FR4) double side PCB, company with large span component, greatly improve reliability in harsh environment, Well designed ventilation and conformal coating , avoid dust accumulation ,improve resistant to corrosion
- Open to customization
Based on powerful controller and open architecture, the product is able to be customized to match need of integration of automatic system or intelligent supervisory system



UPS Outlook

1 Front View

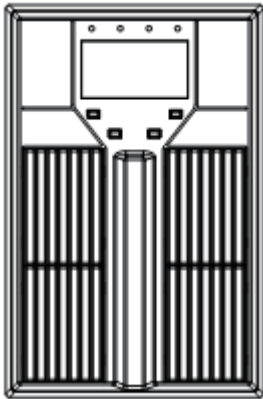

CNH110-1K(S) Bezel with 4 Button

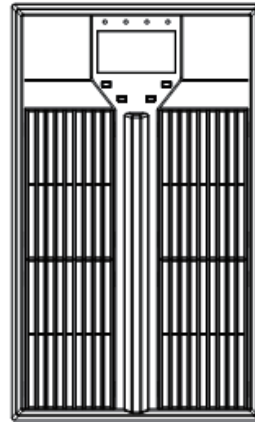

CNH110-2K(S) / CNH110-3K(S) Bezel with 4 Button

2 Rear View

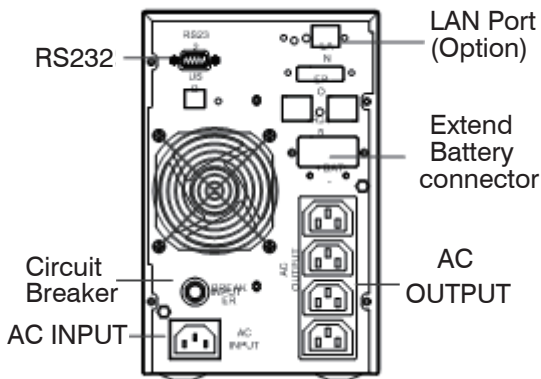

CNH110-1/2K

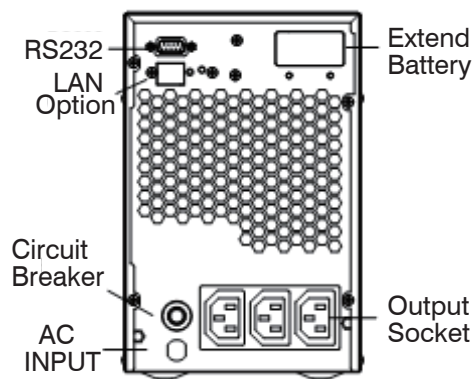

CNH110-1KS/2KS

3

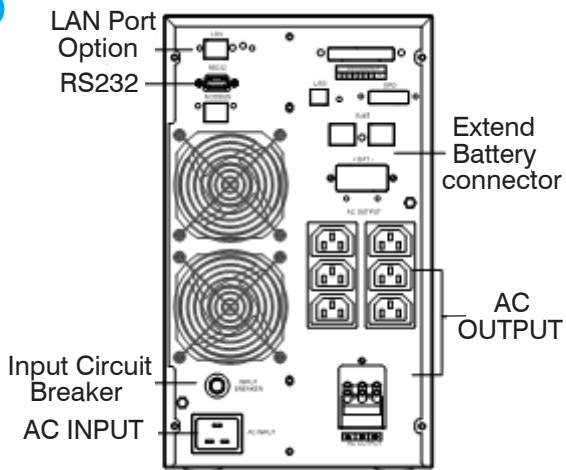

CNH110-3K_HV Rear Panel

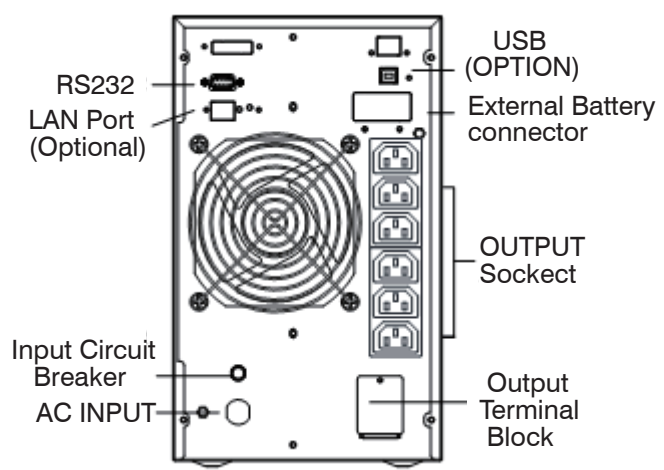

CNH110-3KS_HV Rear Panel



PRODUCT PARAMETERS

Model		CNH110-1k	CNH110-1kS	CNH110-2k	CNH110-2kS	CNH110-3k	CNH110-3kS
Capacity	VA/ W	1kVA/800W		2kVA/1.6 kW		3kVA/2.4 kW	
Topology		Double Conversion Online UPS					
Phase		Single Phase Input Single Phase Output					
Mains Input	Wiring	L/N+PE					
	Rated Voltage	208/220/230/240VAC					
	Voltage Range	90~300VAC					
	Frequency Range	40Hz-70Hz					
	Input Power Factor	≥0.99					
AC Output	Wiring	L/N+PE					
	Output Voltage	208/220/230/240VAC					
	Voltage Regulation	±1%					
	Output Frequency	50/60±4Hz(Sync Mode)/50/60Hz±0.1%(Free Run)					
	Waveform	Pure Sine Wave					
	Distortion (THDV%)	<2%(Linear Load)					
		<7%(None-Linear Load)					
Over load capability	1Min@105%~125%Rated Load 30Sec.@125%~150%Rated Load 0.5Sec.@>150%Rated Load						
Efficiency	AC/AC Mode	88%		89%		90 %	
	DC/AC Mode	86%		87%		89%	

Note:

- ① Battery Capacity and voltage is open to customization
- ② Dimension might vary for different bezel
- ③ The socket and terminal configuration on the rear panel may be different for countries or regions according to order
- ④ More parameter customization , please contact sales representative



PRODUCT PARAMETERS

Model		CNH110-1k	CNH110-1kS	CNH110-2k	CNH110-2kS	CNH110-3k	CNH110-3kS
Battery & Charge	Rated Battery Voltage ^①	24VDC Internal	36VDC External	48VDC Internal	72VDC External	72VDC Internal	96VDC External
	Battery Capacity	12V/7AH X2pcs	External Battery Depends	12V/7AH X4pcs	External Battery Depends	12V/7AH X6pcs	External Battery Depends
	Backup Time	>6mins@ Half Load		>6mins@ Half Load		>6mins@ Half Load	
	Charging Current	Standard Model with Internal Battery : 1A Long Backup Time Model : 4A					
Physical	Chassis Style	Tower					
	Tower Dimension	1KS: 145(W)x220(H)x250(D)mm 1K,2KS: 145(W)x220(H)x318(D)mm 2K: 145(W)x220(H)x390(D)mm 3K/3KS: 190(W)x318(H)x368(D)Dmm					
	Weight (kg)	8.9	4.2	14	5.9	21.9	8.3
HMI	LCD DISPLAY	Input Mains Voltage,Frequency,Load level,Operation Mode,Health Status					
	Standards Communication Interface	1. RS232 PORT					
	Optional Extension Card	2.NMC Card: Support remote monitor the UPS via Smart Phone APP,Web Page, PC Monitor Software, Support Server / NAS shut down 3.MOVBUS Card 4.USB Card 5.Relay Card (Needs assembly according to order request before shipping)					
Operating Environment Endurance	Temperature range	-10~50 ℃					
	Relative Humidity	0-98% (Non-condensing)					
	Acoustics Noise	<55dB @ 1 meters					

